

THE GENERAL RADIO

# EXPERIMENTER



VOLUME 34 Nos. 11 & 12

NOVEMBER-DECEMBER, 1960

IN THIS ISSUE



Vibration Calibrator  
Vibration Pickup  
New Variac<sup>®</sup> Autotransformers  
New Decade Resistance Boxes  
Quartz-Crystal Discriminator



IET LABS, INC in the GenRad tradition  
534 Main Street, Westbury, NY 11590

www.ietlabs.com  
TEL: (516) 334-5959 • (800) 899-8438 • FAX: (516) 334-5988



©1960—GENERAL RADIO COMPANY, WEST CONCORD, MASS., U.S.A.

Published Monthly by the General Radio Company  
VOLUME 34 • NUMBERS 11 & 12 NOV.-DEC., 1960

## CONTENTS

	Page
Little Dithers.....	3
Type 1560-P11 Vibration Pickup System.....	5
New Instruction Book for the Transfer-Function Bridge..	7
Standard Inductor.....	7
New Metered Variac® Autotransformers.....	8
Type W5LMT3 Variac® Autotransformer.....	9
New Decade Resistance Boxes.....	9
A Quartz-Crystal Frequency Discriminator.....	11
Interkama 1960.....	12

The General Radio EXPERIMENTER is mailed without charge each month to engineers, scientists, technicians, and others interested in electronic techniques in measurement. When sending requests for subscriptions and address-change notices, please supply the following information: name, company address, type of business company is engaged in, and title or position of individual.

## GENERAL RADIO COMPANY

West Concord, Massachusetts

Telephone: (Concord) EMerson 9-4400; (Boston) CLearwater 9-8900

**NEW YORK:** Broad Avenue at Linden, Ridgefield, New Jersey  
Telephone — N. Y., WOrth 4-2722  
N. J., WHitney 3-3140

**CHICAGO:** 6605 West North Avenue, Oak Park, Illinois  
Telephone — VillAge 8-9400

**PHILADELPHIA:** 1150 York Road, Abington, Pennsylvania  
Telephone — Phila., HAncock 4-7419  
Abington, TURner 7-8486

**WASHINGTON:** 8055 13th St., Silver Spring, Maryland  
Telephone — JUniper 5-1088

**LOS ANGELES:** 1000 North Seward St., Los Angeles 38, Calif.  
Telephone — HOLlywood 9-6201

**SAN FRANCISCO:** 1186 Los Altos Ave., Los Altos, Calif.  
Telephone — WHitecliff 8-8233

**CANADA:** 99 Floral Parkway, Toronto 15, Ontario  
Telephone — CHerry 6-2171

### REPAIR SERVICES

**EAST COAST:** General Radio Co., Service Dept., 22 Baker Avenue,  
West Concord, Mass.  
Telephone — Concord, EMerson 9-4400  
Boston, CLearwater 9-8900

**NEW YORK:** General Radio Co., Service Dept., Broad Ave. at  
Linden, Ridgefield, New Jersey  
Telephone — N. Y., WOrth 4-2722  
N. J., WHitney 3-3140

**MIDWEST:** General Radio Co., Service Dept., 6605 West North  
Ave., Oak Park, Illinois  
Telephone — VillAge 8-9400

**WEST COAST:** General Radio Co., Service Dept., 1000 North Seward  
Street, Los Angeles 38, Calif.  
Telephone — HOLlywood 9-6201

**CANADA:** Bayly Engineering, Ltd., First St., Ajax, Ontario  
Telephone — Toronto EMPire 2-3741

### COVER



Calibrating the Type 761-A  
Vibration Meter with the  
Type 1557-A Vibration  
Calibrator.



## LITTLE DITHERS

### A Small, Self-Contained, Self-Excited Vibration Calibrator

The accuracy of sound and vibration measurements in the field is greatly enhanced if the calibration of the measuring system can be checked against a stable, known source immediately before and after the measurements. The TYPE 1552-B Sound-Level Calibrator<sup>1</sup> is widely accepted as such a reference source for sound measurements. The new TYPE 1557-A Vibration Calibrator, shown in Figure 1, now performs a similar function for vibration measurements.

This calibrator generates a monitored vibration level of 1 g, rms, acceleration at 100 cycles per second for the calibration of any vibration pickup that is attached to it. It was originally developed to calibrate the TYPE 761-A Vibration Meter, as illustrated on the cover of this issue, or the TYPE 1560-P11 Vibration Pickup System.<sup>2</sup> It will serve equally well to calibrate most of the one-hundred-plus types of piezo-electric

accelerometers now available or moving-coil velocity pickups weighing 300 grams or less. It can provide on-the-spot calibrations of vibration measuring systems immediately before and after important measurements and also can be used to compare transducers or to calibrate working transducers against a laboratory standard transducer.

#### DESCRIPTION

The TYPE 1557-A Vibration Calibrator is a small shaker driven by an internal, transistorized, electromechanical oscillator. The functional diagram, Figure 2, shows both design and construction. The moving part,  $M_1$ , is concentrically and resiliently mounted within the cylindrical main body,  $M_2$ , of the shaker, which is in turn resiliently mounted to the calibrator case. The transistor amplifier supplies energy to the drive coil of  $M_1$ , while the pickup coil feeds back energy to maintain oscillation and operates the indicating meter. The shaker motion is sinusoidal, and the frequency of the electromechanical oscillator is 100 cps, but the main shaker body,  $M_2$ , with its suspension resonates below 10 cps. Small changes in the mass of  $M_2$  caused by addition of the mass of a vibration pickup, for example, have a negligible effect on the motion of  $M_1$ , while the motion of  $M_2$  is determined by the ratio of  $M_1$  to  $M_2$ . The mass of  $M_2$  is always more than 10 times the mass of  $M_1$  and so, for 1 g acceleration of the shaker body,  $M_1$  must shake in excess of 10 g. When the mass of the shaker body is increased by that of a vibration pickup,



Figure 1. Panel view of the Vibration Calibrator.

<sup>1</sup>Gross, E. E., "An Improved Sound-Level Calibrator," *General Radio Experimenter*, 30, 1, June, 1955.

<sup>2</sup>See page 5 this issue.

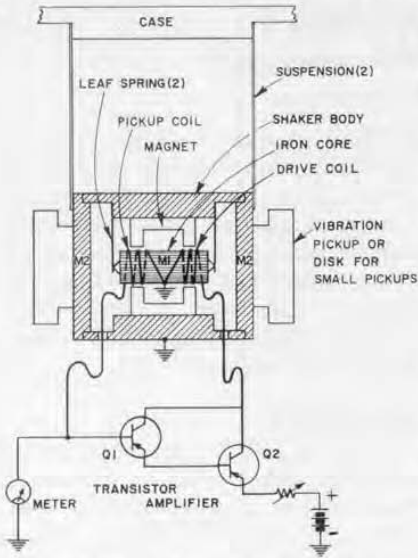

Figure 2. Functional diagram of the calibrator.

the motion of  $M_1$  must be increased to maintain the acceleration of  $M_2$  at the 1 g level. The motion of  $M_1$  is monitored by the panel meter, which is calibrated to register the motion of  $M_1$  that is required to maintain  $M_2$  at 1 g as a function of the added load. The scale reads directly in shaker load from 100 to 300 grams. The load is made up of two removable 50-gram discs and/or the vibration pickup or pickups being calibrated.

## OPERATION

Operation of the calibrator is simple. A pickup of known mass is attached to the shaker, either in place of one of the removable 50 gram discs or to one of the discs by means of double-faced pressure-sensitive tape.<sup>3</sup> The calibrator is turned on, and the output is set to 1 g rms by adjustment of the LEVEL

<sup>3</sup>Angiers Adhesives, Division of Interchemical Company; Scotch Brand, Minnesota Mining and Manufacturing Company.

control until the panel meter indication corresponds to the mass, in grams, of the total external load on the shaker. For example, in the calibration of a tiny accelerometer weighing 20 grams, the accelerometer is attached to one of the discs with double-faced pressure-sensitive tape, and the LEVEL control is adjusted so the meter reads 120 (the mass of the accelerometer plus the mass of the two 50 gram discs).

When the General Radio TYPE 1560-P51<sup>2</sup> Pickup (50 grams) is calibrated, one disc is replaced by the pickup and the meter reading is set to 100. For the General Radio TYPE 761-P1 759-P35 Pickup (215 grams), both discs are removed and the correct meter reading is 215.

Life tests on the calibrator indicate that it will operate continuously at maximum output for over 1000 hours. Since normal operation will usually be below the maximum and will not be continuous, the unit should give trouble-free service for many years.

The rms velocity at 100 cps for 1 g rms acceleration is 0.614 inch per second and the corresponding rms displacement is 0.000978 inch. The total excursion (peak-to-peak displacement) of the shaker body or pickup is 0.00277 inch.

## EXTERNAL FIELDS

The magnetic fields measured near the calibrator are maximum at the right-hand side of the instrument as one looks at the panel. The dc field is 100 gauss or lower when the right-hand 50 gram disc is removed. Under the same conditions the ac field is less than 1 gauss. The measured stray magnetic fields are somewhat lower at the left-hand side of the instrument, and so one should mount pickups that may be susceptible on that side.



### ACKNOWLEDGMENT

The TYPE 1557-A Vibration Calibrator is an extension of an original design by D. V. Noiseux of Bolt, Beranek, and

Newman, Inc. The present mechanical and magnetic design was engineered by P. K. McElroy.

— E. E. Gross, Jr.

### SPECIFICATIONS

**Output:** Acceleration, 1 g rms  $\pm 10\%$ .  
Velocity, 0.614 in. sec.  
Displacement, 0.000978 in., rms, 0.00277 in., peak to peak.  
**Frequency:** 100 c  $\pm 1\%$ .  
**Battery:** 4 RM-4 Mercury cells or equivalent.

**Battery Life:** 100 hrs. of continuous operation.  
**Accessory Supplied:** Leather carrying case.  
**Dimensions:** 4 by 8 by 4 inches (102 by 204 by 102 mm).  
**Weight:** 3 $\frac{1}{4}$  pounds (1.5 kg), including leather carrying case.

Type	Code Word	Price
1557-A   Vibration Calibrator.....	VIVID	\$225.00

## TYPE 1560-P11 VIBRATION PICKUP SYSTEM

New Ceramic Pickup — New Control Box for Use with Type 1551 Sound-Level Meters

A new barium-titanate accelerometer (TYPE 1560-P51) with excellent characteristics is now available as an accessory input transducer for the sound-level meter. A new control box (TYPE 1560-P21) to complement the electrical characteristics of the pickup has been designed. It mounts on the end of the sound-level meter and provides storage for the pickup, extension probe, tips, and cable. The combination is called the TYPE 1560-P11 Vibration Pickup System and is shown in Figure 1.

### USES

The Vibration Pickup System converts the sound-level meter to a general purpose Vibration Meter. For a very modest investment, one can now put the precision attenuators, amplifiers, and metering circuit of his sound-level meter to work in the field of vibration measurements. As modern production machinery and vehicles are designed to go faster and last longer, vibration studies during de-

velopmental and testing stages are becoming more and more important. Operator comfort and safety as well as machinery or vehicle life depend to a large extent on smooth, vibration-free operation. The TYPE 1560-P11 Vibration Pickup System is a convenient means for making these measurements. The pickup system also increases the usefulness of the sound-level meter as a noise-control instrument. Noises caused by solid-borne vibrations can be more easily tracked down. Detection of excessively noisy or worn machinery is often possible, even in



Figure 1. View of the Vibration Pickup System attached to the Type 1551-B Sound-Level Meter.



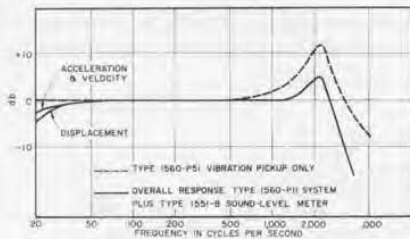

Figure 2. Frequency response of the pickup (dotted curve) and the complete system (solid curve).

the presence of high ambient noise levels, by use of a vibration pickup in place of the microphone on the sound-level meter. Vibration measurements are also often used for production noise testing of silent small mechanisms and motors where airborne noise tests are impossible even with very low ambient noise levels. Routine vibration-level checks on operating machinery are an aid to preventive maintenance on machinery when vibration levels begin to climb, but before excessive wear that causes noise and failure occurs.

Vibration measurements can be used to supplement sound-level measurements made for noise control purposes in buildings. Floors, walls, piping, ventilating ducts, all are sources of noise that can be sought out by using a vibration pickup.

Other uses include the measurement of all types of machinery vibration to determine the need or effectiveness of special shock mountings or to determine the motion of large panels or supports which could cause noise.

### CHARACTERISTICS

The frequency response of the TYPE 1560-P51 Pickup for constant acceleration is shown by the dotted curve of Figure 2. The over-all response of the TYPE 1560-P11 system for constant acceleration, velocity, or displacement is

shown by the solid curves of Figure 2. As indicated, the response of the system is flat within  $\pm 1$  db ( $\pm 12\%$ ) from 30 to 1500 cps.

The nominal sensitivity of the pickup is 40 mv/g. The control box provides a gain control (set at the factory to match the pickup sensitivity to that of the sound-level meter) plus integrating circuits to convert the acceleration response to velocity and displacement. The factors for converting decibel readings to vibration quantities are indicated on the control box name-plate as are the data relating pickup and control box to the proper sound-level meter. Conversion charts are supplied in the instruction booklet so that decibel readings for acceleration, velocity, or displacement are readily translated to rms inches per sec,<sup>2</sup> inches per sec, or inches.

The maximum acceleration that can be measured before the pickup becomes non-linear is 100 g (38,600 inches/sec<sup>2</sup> or just under 132 db reading on the sound-level meter).

The maximum velocity and displacement readings are a function of frequency and are determined by the 100-g limit on the pickup. At 20 cps, for example, the maximum velocity would be 307 inches/sec (approx. 130 db) and the maximum displacement would be 2.44 inches (approx. 118 db).

The minimum acceleration measurement (sound-level meter reading of 30 db) is 0.32 in./sec<sup>2</sup> or .008 g. The corresponding minima for velocity and displacement are .003 in./sec and 100  $\mu$  inches respectively.

Safe operating temperature for the pickup extends from 0 to 200°F. Over the temperature range of 30 to 180°F., the sensitivity remains constant within  $\pm 10\%$ .

Except for temporary surface leakage



across the ceramic unit, cables, and high value resistors in the control box, high humidity has no serious effect on the operation of the system. Dry atmospheres have no ill effect.

### CALIBRATION

Absolute sensitivity of the pickup is measured at low frequencies on an electrodynamic shaker. The displacement of the shaker is accurately determined with a measuring microscope and stroboscopic illumination of fiducial marks on the shaker table. At frequencies above 100 cps, the response of the pickup is measured on a small

piezo-electric shaker. The response of each pickup is checked over the frequency range of 10 cps to 5 kc. The electrical responses of the networks in the control box are also carefully checked over the frequency range of 20 cps to 5 kc. The system can be readily checked with the TYPE 1557-A Vibration Calibrator (see page 3). This new TYPE 1560-P11 Vibration Pickup System replaces the TYPE 759-P35 Vibration Pickup and TYPE 759-P36 Control Box which have been supplied for many years as an accessory input system for sound-level meters.

— E. E. GROSS, JR.

### SPECIFICATIONS

**Calibration:** The db readings of the sound-level meter can be converted into absolute values of displacement, velocity, or acceleration by means of calibration data supplied.

**Range:** The range of measurement of the pickup and control box when used with the TYPE 1551-B, TYPE 1551-A, or the TYPE 759-B Sound-Level Meter is approximately as follows:

Rms Displacement — 100 micro-inches (minimum).

Rms Velocity — 3000 micro-inches per second (minimum). The upper limit of velocity

and displacement measurements is dependent on the frequency and is determined by the maximum acceleration permissible before non-linearity occurs (100 g).

Rms acceleration — 0.3 to 39,000 in./sec/sec (100 g).

**Net Weight:** TYPE 1560-P51 Vibration Pickup, 1.6 ounces (45 g) (pickup only); pickup plus 5-foot cable probe, and tips, 8 ounces (0.3 kg); TYPE 1560-P21 Control Box, 1 pound, 3 ounces (0.6 kg).

Type	Code Word	Price
1560-P11	Vibration Pickup System.....	PIKUP   \$130.00

## NEW INSTRUCTION BOOK FOR THE TRANSFER-FUNCTION BRIDGE

We have recently prepared a revised version of the operating instructions for the TYPE 1607-A Transfer-Function and Immittance Bridge. This new and greatly enlarged edition contains a great deal more operating information than does the first edition, including a com-

plete section on tunnel-diode measurement. Single copies will be gladly furnished without charge to users of the instrument. Requests should include the serial number of the instrument with which the book is to be used.

### STANDARD INDUCTOR

From last month's article on new standard inductors, the following identification and price data were inadvertently omitted.

Type	Code Word	Price
1482-A	Standard Inductor, 50 $\mu$ h.....	INDUCTOGAP   \$125.00





## NEW METERED VARIAC® AUTOTRANSFORMERS

Metered Variacs are portable testing devices, each consisting of a Variac autotransformer, a voltmeter, and an ammeter or a wattmeter or both. Switching, fuses, and 3-wire power cord are also provided. These handy, compact assemblies have many uses both in the laboratory and on the test bench, among them overvoltage and undervoltage tests, trouble shooting, and measurements of voltage, current, and power.

Meters are shielded from the transformer stray field, permitting an over-all accuracy of 3% of full scale. The on-off switch disconnects both sides of the line. Make-before-break switches permit the

dual-range ammeters and voltmeters to be switched under load.

Three new models are now available, in addition to the two (TYPES W5MT3A and W5MT3W) previously announced.<sup>1</sup> For convenient reference, all five available models are listed below.

The new TYPE W10MT3A and TYPE W10MT3W duplicate in the 10-ampere rating the features of the 5-ampere models previously announced. The TYPE W5MT3AW offers the advantage of all three meters — reading load volts, amperes, and watts — in a single assembly.

<sup>1</sup>"New Metered Variacs, TYPES W5MT3A, W5MT3W," *General Radio Experimenter*, 33, 5, May, 1959.

Type	Input Voltage	Output Voltage*	Output Current (Amperes)	Meter Ranges		Code Word	Price
				Amperes	Watts		
W5MT3A	120	0-140	0-5	0-1 0-5	None	CABAL	\$89.00
W5MT3W	120	0-140	0-5	None	0-150 0-750	CABOB	112.00
W5MT3AW	120	0-140	0-5	0-1 0-5	0-150 0-750	CABEX	150.00
W10MT3A	120	0-140	0-10	0-2 0-10		DOGEN	110.00
W10MT3W	120	0-140	0-10		0-300 0-1500	DOGID	138.00

\*Voltmeter range is 0-150

Type W5MT3AW Metered Variac.



Type W10MT3A Metered Variac.







## TYPE W5LMT3 VARIAC<sup>®</sup> AUTOTRANSFORMER

The popular TYPE W5L Variac<sup>®</sup> Autotransformer is now available in a portable model, TYPE W5LMT3, with case, handle, on-off switch, overload protector, 3-wire cord and plug, and 3-wire outlet. Maximum output voltage is limited to input line voltage, which permits a maximum current of 9.2 amperes and an output rating of 1.1 kva. Rated current of 7.1 amperes can be drawn at any point on the winding; maximum current can be drawn at, or near, maximum voltage only. A load drawing not more than maximum current at maximum voltage can be controlled over the full range of output voltage (0 to 120).

The combination of portability, high rating, 3-wire plug, and built-in overload



View of the Type W5LMT3 Variac<sup>®</sup> Autotransformer. The 3-wire to 2-wire adaptor shown at the right is furnished.

protector make this Variac a most useful device for general testing in the laboratory and shop.

### SPECIFICATIONS

**Input Voltage:** 120.

**Output Voltage:** 0-120.

**Rated Current:** 7.1 amperes.

**Maximum Current:** 9.2 amperes.

**Load Rating:** 1.1 kva.

**Driving Torque:** 10-20 ounce-inches (700-1400 gm-cm).

**Case Dimensions:** (Height)  $6\frac{7}{16}$  x (width)  $4\frac{7}{8}$  x (depth)  $4\frac{1}{4}$  inches (168 x 124 x 108 mm), not including handle and cord.

**Net Weight:**  $8\frac{1}{4}$  pounds (3.75 kg).

Type		Code Word	Price
W5LMT3	Variac <sup>®</sup> Autotransformer .....	COTOS	\$34.50
VB-2	Replacement Brush.....		.75

## NEW RESISTANCE DECADE BOXES WITH IMPROVED SWITCHES

After having for several years fulfilled on a special basis many requests by customers for decade resistance boxes containing steps of 0.01 ohm, we are now adding to the line two new items, TYPE 1432-T: 1,111.1 ohms, 5 dials, in steps of 0.01 ohm, and TYPE 1432-U: 111.1 ohms, 4 dials, in steps of 0.01 ohm.

The 0.01-ohm-per-step decade greatly enhances the usefulness of a multi-dial

decade resistor. If, in a particular application, the lowest decade is used as the last of several decades, its relative inaccuracy ( $\pm 2\%$ ) is swamped out by the high resistance in series with it. Even when this lowest decade is used with only one or two others, it still can be very useful in making precise adjustment to a desired circuit condition, as, for instance, a null balance in an im-



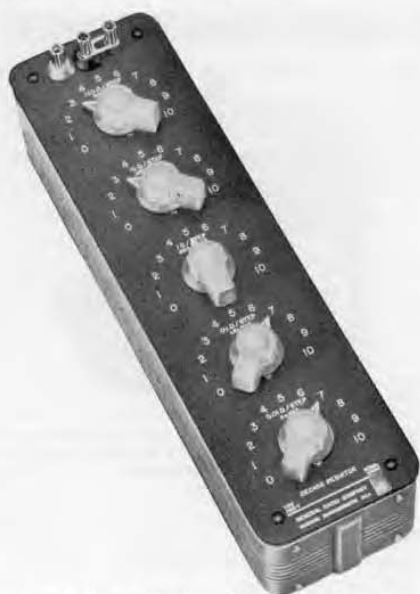

Figure 1. View of the Type 1432-T Decade Resistor.

pedance bridge. Used in an ac bridge to set the resistive balance, its high resolution permits a corresponding sharpening of the null, so that the desired reactive balance can be set with greater precision.

While the 0.01 ohm-per-step TYPE 510 Decade-Resistor Unit had been manufactured for some time on a special basis for selected uses, it became possible to catalog it for separate sale (as TYPE 510-AA) and to use it in decade resistance boxes only when the low-residual-resistance version of the TYPE 510 Switch, about to be described, came into production.

This basic change in the TYPE 510-P3 and -P3L Switches was made for the purpose of reducing the switch resistance, which is stated as being between 0.002 and 0.003 ohm in our current Catalog P. Use of two silver-bearing alloys as the materials from which to make the contact buttons, switch brushes, and take-off springs has resulted in a decrease of this resistance by a factor of three or four to one. This means that the switch resistance on a normal switch will not exceed one milliohm, even under extreme conditions of resistance variation.\* (See Figure 2 for typical variation of resistance *vs.* time for old and new metal combinations.)

Since the two new alloys referred to above are high-copper alloys, having small silver additions rather than a large proportion of zinc, they appear redder in color than the earlier alloys. Because the high-copper alloys are more subject to corrosion by atmosphere or finger marking, a number of corrective measures have been taken. The brushes are nickel-plated, except on the contact surfaces, to maintain appearance. The take-off springs are silver-plated to assure persistence of the originally low contact

\*In this connection it should be pointed out that the switch resistance tends to increase under circumstances where the switch has not been moved for a long period of time. This is true of even the best switch materials, such as silver. It is always prudent, after a box has stood with one or more switches in a given position for any considerable period, to give the switches several swings back and forth over the full range of their motion. This will dissipate by friction any foreign products which may have built up on the switch resistance during the period of inactivity. This should become as much a matter of habit as brushing one's teeth or cleaning one's spectacles.

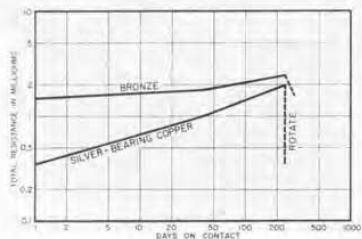

Figure 2. (Left) Change in switch resistance as a function of time when left at rest. When switch is rotated, the resistance drops immediately to its original value.



(Right) Change in switch resistance as a function of cycles of operation for bronze and silver-bearing-copper alloys.



resistance, which improves their solderability at the same time. New lubricants, otherwise similar to what had been in use, but having strong antioxidant properties, are employed. That used at the contact-button-brush interface is Master Lubricant's H101, available for

maintenance purposes from our Service Department in four-ounce tubes at 75 cents per tube. This lubricant is equally satisfactory for use on older TYPE 510 Switches having phosphor-bronze brushes and Tobin-bronze contact buttons.

— P. K. McELROY

Type		Code Word	Price
1432-T	1,111.1 ohms in steps of 0.01 ohm.....	DEVIL	\$120.00
1432-U	111.1 ohms in steps of 0.01 ohm.....	DEWIN	95.00

## A QUARTZ-CRYSTAL FREQUENCY DISCRIMINATOR

NOTE: This discriminator is not built for sale by the General Radio Company. The description is published for the information of those who may wish to build their own. —Ed.

During the development of low-noise frequency-multiplier systems, a sensitive frequency discriminator was devised to measure the dynamic frequency modulation present in the output signal from the multiplier. The discriminator, which is described here, provides a sensitivity adequate for the measurement of deviations of  $\pm 1 \times 10^{-9}$  or less when a narrow-band wave analyzer is used to select the modulation-frequency components.

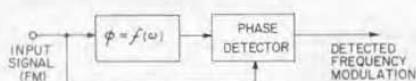

Figure 1. Block diagram of the discriminator.

The circuit makes use of the steep phase-vs.-frequency characteristic of a quartz crystal at series resonance to provide the required sensitivity. A balanced phase-detector circuit is used to reduce the effects of amplitude modulation. The block diagram of the circuit shows that it belongs to the class of frequency discriminators in which the input signal is applied to a phase detector through one channel with negligible phase shift and through a second channel with a phase shift that is a function of frequency.

The circuit is similar to the Foster-Seeley discriminator circuit insofar as the balanced phase-detector circuit is concerned. The inherent tuned-circuit phase shift, however, which is the basis of the operation of the Foster-Seeley discriminator, is negligible compared with the phase shift produced in the series-resonant crystal as the input frequency varies about the series-resonant frequency. The slope of the phase-shift characteristic in the quartz crystal branch is larger in comparison with that in the LC circuit by approximately the ratio of the  $Q$ 's of the resonant elements, or approximately  $\frac{100,000}{100} = 1000$ . Hence the phase characteristic of the quartz crystal dominates that of the inductance-capacitance circuit.

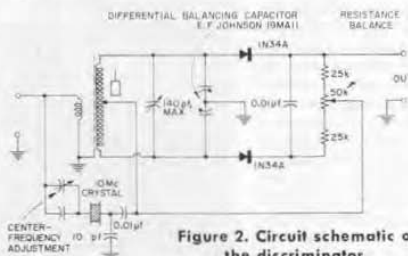

Figure 2. Circuit schematic of the discriminator.

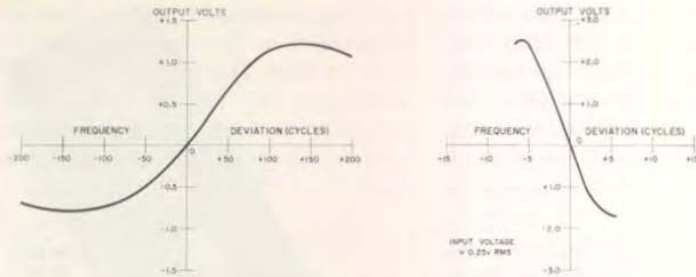

Figure 3. Response characteristic of (left) the 10-Mc discriminator and (right) the 1-Mc discriminator.

The principal series resonance of the crystal presents a very low impedance in the signal path, whereas the shunt resonance of the crystal with its own electrode capacitance presents a high impedance. Hence the shunt-resonant point, which would otherwise represent a possible spurious response, has negligible influence.

The frequency of the series-resonant response of the quartz crystal is adjustable by means of the adjustable series capacitor. The bandwidth of this response is affected by the shunt capacitor, connected between the center-top of the coil and ground. A large capacitor here produces a narrow-band response (maximum  $Q$ ) as

it does in any crystal filter circuit.

The response of the discriminator is limited to modulation frequencies within the pass band of the crystal branch. Modulation-frequency side bands beyond the bandwidth of the crystal element are not passed. The 10-Mc discriminator described has been used to measure 60-cycle and 100-cycle modulation, and to estimate 120-cycle modulation. It is not effective for higher modulation rates. A 1-Mc discriminator has also been built but is not effective for modulation rates above approximately 10 cycles/sec, and hence is not useful for the measurement of power-supply-related modulation.

—FRANK D. LEWIS

## INTERKAMA 1960

View of the General Radio booth at Interkama 1960, the International Congress and Exhibition for Instrumentation Control and Automation, held at Düsseldorf, October 19 to 26. Shown at rear of the

booth are (left) Dr.-Ing. Günter Nüsslein, General Radio representative in Germany, and (right) Peter J. Macalka, engineer from the General Radio factory. The ladies in the foreground are Miss Schuhmacher, Dr. Nüsslein's secretary, and Mrs. Macalka. Also in attendance were Robert A. Soderman, Administrative Engineer, and General Radio representatives from principal European countries.



# General Radio Company



IET LABS, INC in the GenRad tradition

534 Main Street, Westbury, NY 11590

TEL: (516) 334-5959 • (800) 899-8438 • FAX: (516) 334-5988

www.ietlabs.com

PRINTED  
U.S.A.